

Genie 400-SL Bench Top Fume Hood

Constant Volume (CAV)

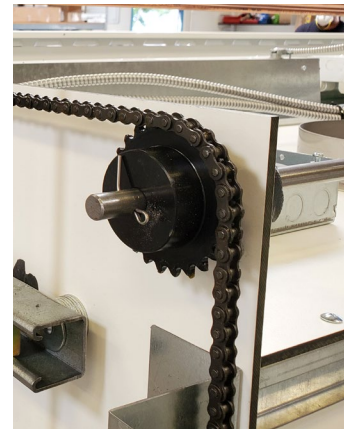

Always Chain Driven

Picture & drawing shown unit with frameless vertical rising sash, standard electrical package; florescent light, light switch, blower switch, two 120v GFI duplex, TEL500 airflow monitor factory pre-wired to JBOX on top of hood. Standard base cabinet, spillsafe phenolic top

UL 1805 Listed & Meets ASHRE-110 test as manufacture red

Additional Options:

- Flammable Storage Cabinet
- Corrosive Storage Cabinet
- Vacuum Pump Cabinet
- Plumbing Fixtures
- Cup Sink
- Specialty Electrical
- Cord Pass-Thru
- CA Title 24 Compliant Auto-Sash Closure
- Remote Exhaust Blower
- Additional Sash Options
- Ceiling Enclosure Panels
- Stainless Steel & Polypro Interior Liner
- Stainless steel & Epoxy Resin SpillSafe Countertop

Standard Features:



ChemTough™ The most durable general purpose fume hood liner on the market comes as the standard option on Genie hoods



PowerLink™ Robust chain and sprocket sash counter balance a system that will never fail, we guarantee it!



SpillSafe™ Fume hood work surfaces are dished to safely contain spills inside the hood.



DirectConnect™ All our hoods are fitted with a simple round exhaust collar for connection to building HVAC. No complicated transition ductwork.

Genie 400-SL Bench Top Fume Hood

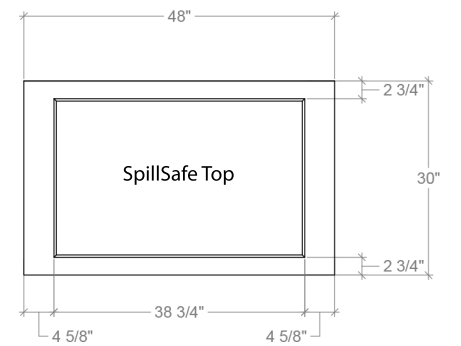
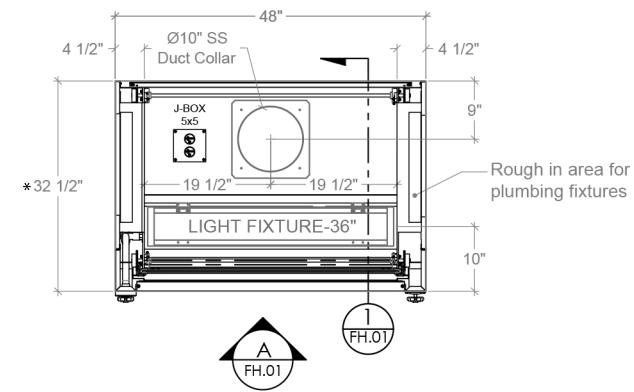

Top View
4' Bench Top Fume Hood

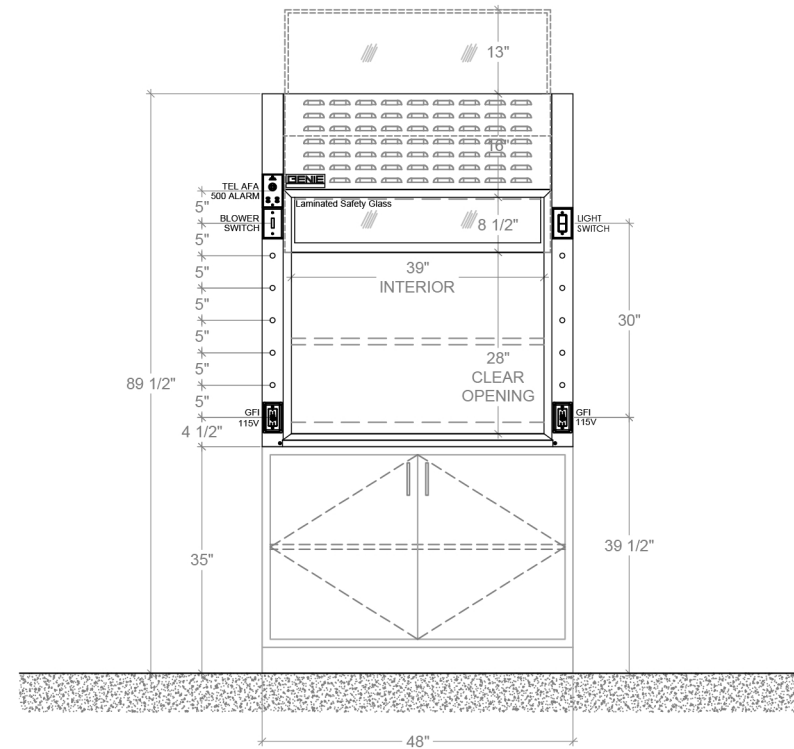

A Front View
4' Bench Top Fume Hood

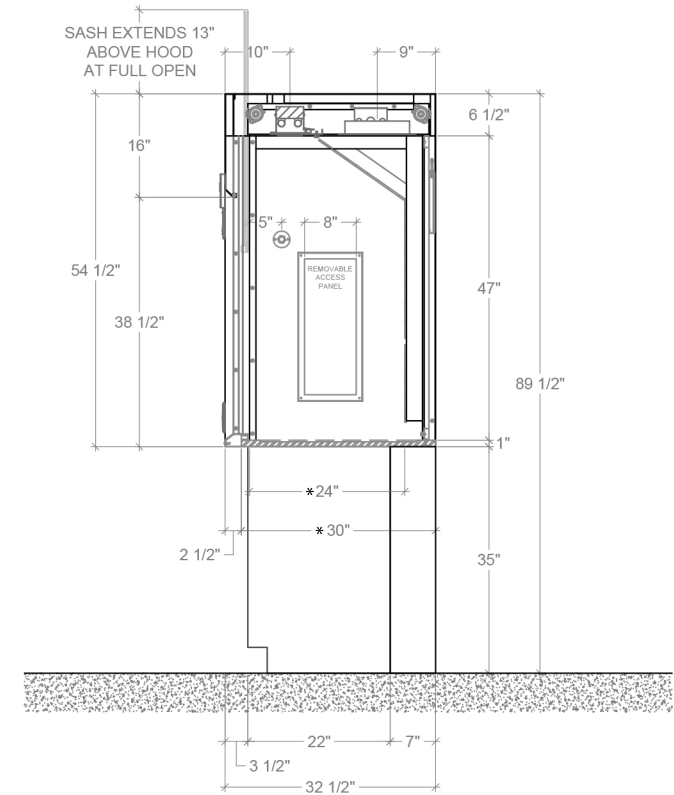

Section 1
4' Bench Top Fume Hood

MODEL #	DIMENSIONS			HOOD OPENING		CFM @ 28"	CFM @ 18"
	W	H	D	W	H	28"H Sash Opening	
Genie 400-SL	48"	54 1/2"	32 1/2"	39"	28"	758 cfm @ .32" sp	488 cfm @ .13" sp

*24" D interior model shown, 30" D, 36" D & custom depths available
Chart Shows Required CFM for 100FPM Face Velocity
Fume Hood Requires a Remote Blower

